

Pos. Nr. Pos.no.	Beschreibung Description	Art.-Nr. Art.no.	Preisgruppe Price bracket
72144	DSB BR50	=	
72145		=	🔊
78145		~	🔊
1	Ölkanne Oil can	92453	4
2	Kesselboden Boiler bottom	132706	12
3	TS-Kesselleitungen Part set boiler wires	100145	9
4	Lokgewicht Loco ballast	109802	8
5	Schaltstange 0,4 x 37 mm Control rod 0,4 x 37 mm	100169	4
6	Schaltstange 0,4 x 49,7 Control rod 0,4 x 49,7	100170	4
7	Schaltstange 0,4 x 93 mm Control rod 0,4 x 93 mm	100171	4
8	Schaltstange 0,4 x 100 mm Control rod 0,4 x 100 mm	100172	4
9	TS - Sandrohr, Kesselrohr Set of sand pipes, boiler pipes	100146	9
10	Kessel Steckteilesatz 2 Boiler plug-in parts set 2	108329	10
11	Kupplungsauflage Coupling cover	100277	4
12	Fenstersatz Window set	100734	12
13	TS - Kesselsteckteile Part set of boiler plug-in parts	100678	13
14	Rauchfang Chimney	141415	6
15	GF-Schraube M2x5 mm Self-tapping screw M2x5 mm	114966	3
16	Sandrohrsatz und Griffstangen Sand pipe and hand-rail set	120206	9
17	TS-Kessel-Tender Part set boiler - tender	120207	8
18	Lichtabdeckung Light cover	122502	3
19	Führerhaus Betr. nr. 203 Driver's cab loco no.203	141414	19
20	Stirnlichtleiter Front light conductor	131122	5
21	Kessel komplett Betr. nr. 203 Boiler assembly Loco.no. 203	141413	39
22	TS - Tender 1 Part set of tender 1	108330	12
23	Umlaufblech Running board	112422	16
24	Stirnlampe Headlight	112423	3
Sound			
25	GF-Schraube M1,6x4 mm Self-tapping screw M1,6x4 mm	114850	3
26	Lautsprecher Loudspeaker	129524	16
27	Lautsprecherplatine PCB for loudspeaker	133613	11
28	Kontaktstift m. Litze Contact pin with lead	132794	4

Änderungen in Konstruktion und Ausführung vorbehalten
We reserve the right to change the construction and specification

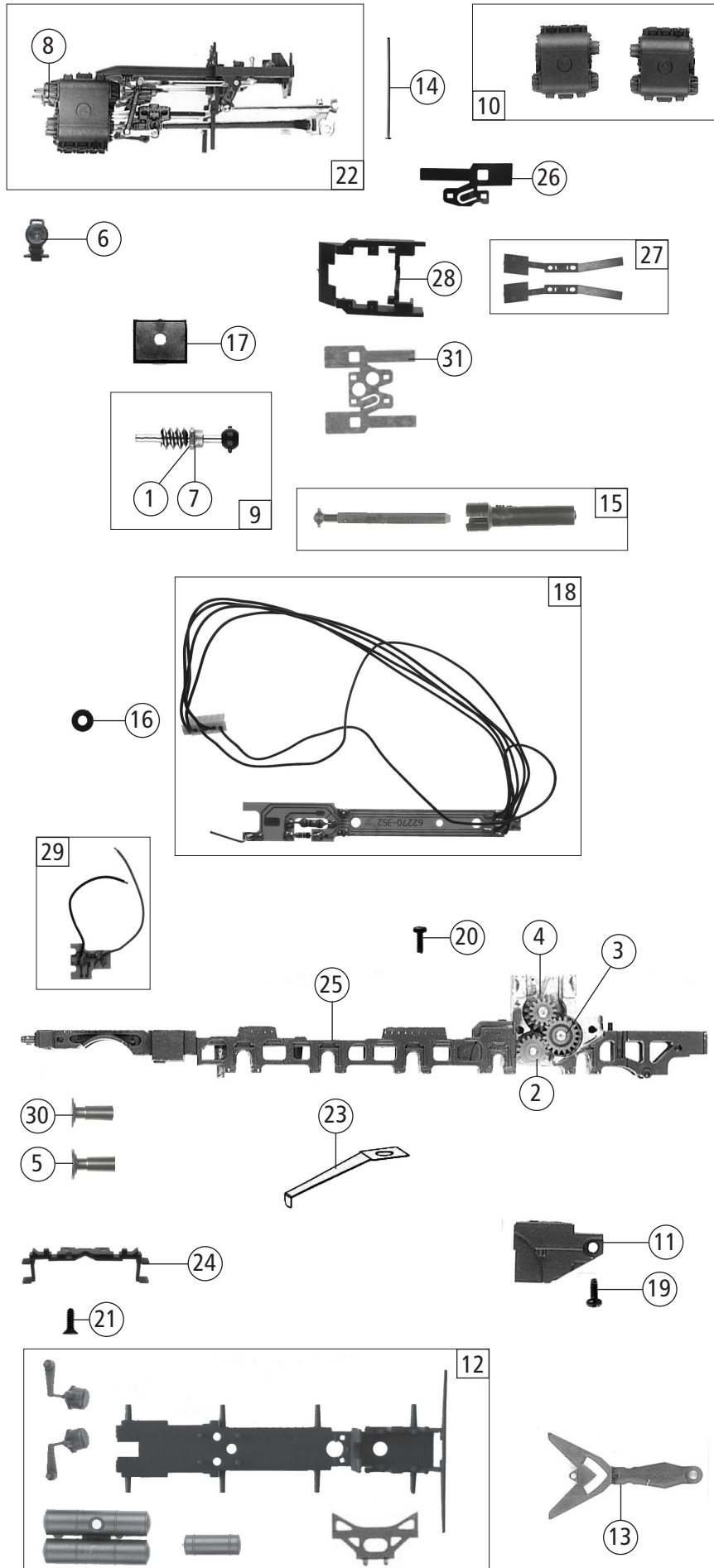

Pos. Nr. Pos.no.	Beschreibung Description	Art.-Nr. Art.no.	Preisgruppe Price bracket
72144	DSB BR50	=	
72145		=	🔊
78145		~	🔊
1	Beilagscheibe Washer	86108	3
2	Zahnrad Z=17 Gear wheel Z=17	86409	5
3	Zahnrad Z=19 M=0,4 Gear wheel Z=19 M=0,4	86417	3
4	Schnecken Zahnrad Z=15/14 Worm gear wheel Z=15/14	86490	5
5	Puffer rund flach Buffer round flat	88556	5
6	Laterne Lamp	105020	4
7	Lager für Schneckenachse Bearing for worm gear axle	89749	6
8	TS - Schiebereinsatz Part set slide inset	92420	3
9	Schneckensatz mit Kardankugel Set of worm gear incl. cardan ball	100132	13
10	Zylinderblock links und rechts Cylinder block left and right	100168	12
11	Getriebedeckel Gear cover	100290	12
12	TS - 5 Bremszylinder, Kessel Part set 5 brake cylinder, boiler	100295	10
13	Lok-Tender-Kupplung Coupling between loco and tender	100296	8
14	Drahtstift Tack	110641	4
15	Kardanwelle und Kardanhülse Cardan shaft and cardan reception	111765	4
16	Platinenring Rim for PCB	125002	9
17	Schneckenkammerdeckel Worm gearbox cover	111987	4
18	Lokplatine komplett Loco PCB assembly	125019	20
19	GF-Schraube M2x5 mm Self-tapping screw M2x5 mm	114966	3
20	GF-Schraube M1,6x4 mm Self-tapping screw M1,6x4 mm	114850	3
21	SK-Schraube M1,6x4 mm SK-Screw M1,6x4 mm	115161	3
22	Steuerung kpl. Reversing gear complete	141410	36
23	Vorlaufstellfeder Bogie spring	125024	3
24	Loktreppe Loco treadle	125083	4
25	Lokgrundrahmen lackiert Loco basic frame painted	112396	16
26	Radkontakt Wheel contact	131126	5
27	Radkontakt links und rechts Wheel contact left and right	124976	6
28	Kontaktträger Contact support	124996	7
29	Stirn-LED-Platine kpl. Front -LED-PCB complete	125020	12
30	Puffer rund gewölbt Buffer round curved	88557	5
AC-Wechselstrom			
31	Radkontakt Wheel contact	131912	4

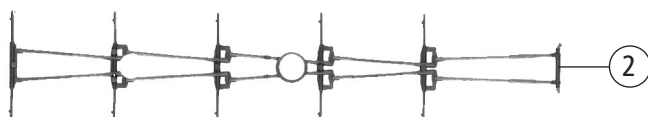
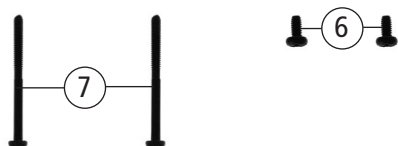
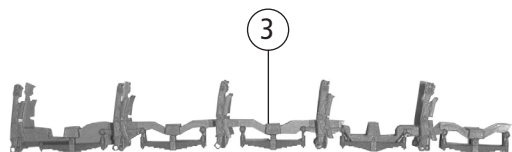
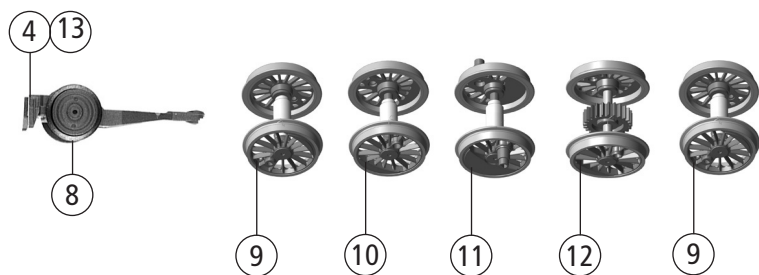

Pos. Nr. Pos.no.	Beschreibung Description	Art.-Nr. Art.no.	Preisgruppe Price bracket
72144	DSB BR50		
72145			🔊
78145		~	🔊
1	TS - Bolzen Kuppelstange Part set bolt coupling rod	138069	5
2	Bremsgestänge Brake rigging	100292	3
3	Bremsrahmen Brakes frame	100308	12
4	Vorlaufgestell Bogie	135479	8
5	TS - Kuppelstangen bedruckt Part set of coupling rod printed	136819	16
6	GF-Schraube M 2x4 mm Self-tapping screw M 2x4 mm	114877	3
7	GF-Schraube M2x25 mm Self-tapping screw M2x25 mm	115533	3
8	Vorlaufradsatz Pony truck wheelset	136817	9
9	Radsatz 1+5 o.Zahnrad o.Haftring Wheelset 1+5 w/o gear wheel and tract.tyre	135481	12
10	Radsatz 2 o.Zahnrad o.Haftring Wheelset 2 w/o gear wheel and tract.tyre	135482	12
11	Radsatz 3 o.Zahnrad o.Haftring Wheelset 3 w/o gear wheel and tract.tyre	135483	12
12	Radsatz 4 mit Zahrad ohne Haftring Wheelset 4 w. gear wheel w/o Haftring	135484	12
AC-Wechselstrom			
13	Vorlaufradsatz AC Pony truck wheelset AC	112404	9

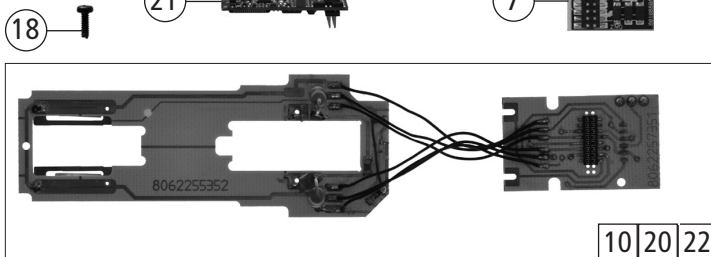
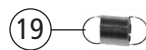
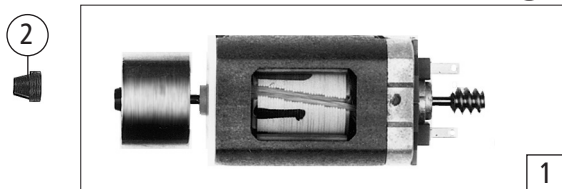
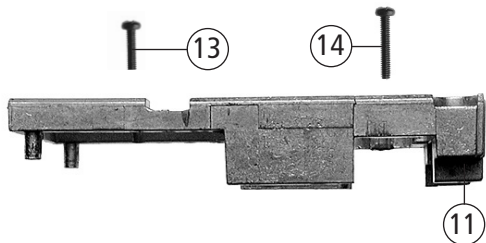
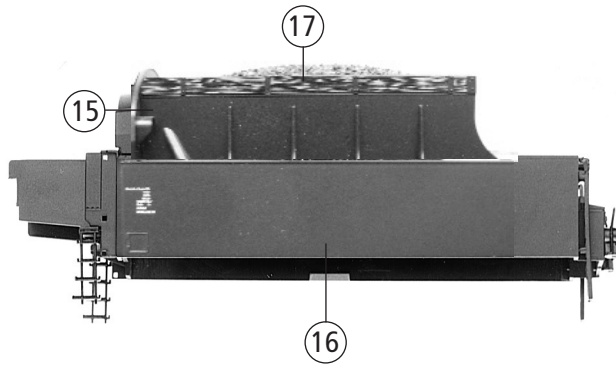
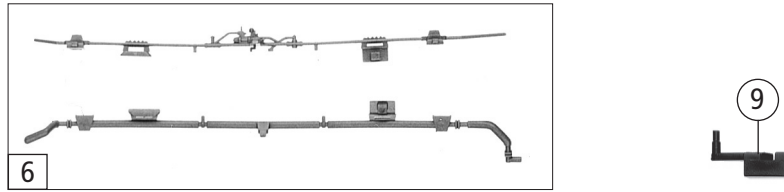

8 o. Abb. / w/o ill.
Tendergrundrahmen
Tender basic frame

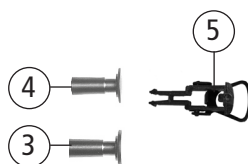
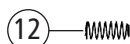

Pos. Nr. Pos.no.	Beschreibung Description	Art.-Nr. Art.no.	Preisgruppe Price bracket
72144	DSB BR50	=	
72145		=	🔊
78145		~	🔊
1	Motor Motor	85131	28
2	Kardanschale kurz 1,5mm Cardan reception short 1,5mm	87129	4
3	Puffer rund flach Buffer round flat	88556	5
4	Puffer rund gewölbt Buffer round curved	88557	5
5	Standardkupplung Standard coupling	89246	6
6	Tenderleitungen links und rechts Tender pipes left and right	100299	7
7	Brückenstecker Connector	129630	10
8	Tendergrundrahmen o.Abb. Tender basic frame w/o illustration	141408	16
9	Kupplungskammer Coupling reception	108225	4
10	Tenderplatine mit LED Tender PCB with LED	131130	24
11	Tendergewicht Tender ballast	109405	8
12	Bürstenfeder Brush spring	114197	3
13	GF-Schraube M1,6x6 mm Self-tapping screw M1,6x6 mm	114836	3
14	GF-Schraube M1,6x10 mm Self-tapping screw M1,6x10 mm	114881	3
15	Kohlekasten und Stirnteil Coal box and frontside part	116381	12
16	Tendergehäuse Betr. nr. 203 Tender body Loco no. 203	141409	14
17	Kohlegewicht Coal weight	109868	10
18	GF-Schraube M1,6x4 mm Self-tapping screw M1,6x4 mm	114850	3
19	Zugfeder Draw spring	86208	3
Sound			
20	Tenderplatine m. LED Tender PCB with LED	132128	28
21	Sounddecoder Sound-decoder	141416	39
AC-Wechselstrom			
22	Tenderplatine m. LED Tender PCB with LED	136938	28

